

**Experimental Entanglement of a Six-Photon
Symmetric Dicke State
— we review a paper
(Lecture of the Quantum Information class of
the Master in Quantum Science and
Technology)**

Géza Tóth

Theoretical Physics, University of the Basque Country (UPV/EHU), Bilbao, Spain
Donostia International Physics Center (DIPC), San Sebastián, Spain
IKERBASQUE, Basque Foundation for Science, Bilbao, Spain
Wigner Research Centre for Physics, Budapest, Hungary

UPV/EHU, Leioa
14 February 2025

1 Motivation

- Why is photonic implementation of quantum information processing interesting?

2 A photonic qubits

- How to store a qubit
- How to measure a qubit

3 A photonic singlet (a two-qubit entangled state)

- Parametric downconversion
- Distribution of the photons with beam splitters and postselection

4 Experiment with Dicke states

- Basic ideas of the experiment
- The setup
- The experiment in real life
- The results

Why is photonic implementation of quantum information processing interesting?

- Advantages

- Photons are inherently two-state systems, they can have a horizontal or vertical polarization.
- They can easily be transmitted in a fibre, even for 100 kilometers.
- There are simple processes that generate entangled photon pairs.
- Highly entangled states can be realized with large fidelity.

- Drawbacks

- Photons do not interact with each other, thus it is not so simple to realize quantum gates.
- The efficiency of photonic detectors is not large, however, it getting better recently.

Outline

1 Motivation

- Why is photonic implementation of quantum information processing interesting?

2 A photonic qubits

- How to store a qubit
- How to measure a qubit

3 A photonic singlet (a two-qubit entangled state)

- Parametric downconversion
- Distribution of the photons with beam splitters and postselection

4 Experiment with Dicke states

- Basic ideas of the experiment
- The setup
- The experiment in real life
- The results

Photons as qubits

- A photon can have a horizontal and a vertical polarization.
- $|H\rangle$ and $|V\rangle$ can take the role of $|0\rangle$ and $|1\rangle$.
- The photon can travel even 100 kilometers on the fiber.

Outline

1 Motivation

- Why is photonic implementation of quantum information processing interesting?

2 A photonic qubits

- How to store a qubit
- How to measure a qubit

3 A photonic singlet (a two-qubit entangled state)

- Parametric downconversion
- Distribution of the photons with beam splitters and postselection

4 Experiment with Dicke states

- Basic ideas of the experiment
- The setup
- The experiment in real life
- The results

Detecting the qubit

- We have to use Polarizing Beam Splitters (PBS). These let photons with a H polarization go through, while they reflect photons with a V polarization.
- Based on these, the following setup measures the photon in the H/V basis (essentially the same as measuring the Pauli spin matrix σ_z)

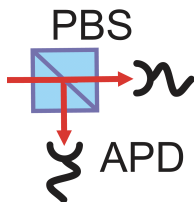

- APD means single-photon avalanche photodiodes. These are detectors that can detect even a single photon.

Figure from [W. Wieczorek, R. Krischek, N. Kiesel, P. Michelberger, G. Tóth, and H. Weinfurter, Phys. Rev. Lett. 2009.]

Detecting the qubit II

- How to measure in some other basis? How to measure σ_x or σ_y ?
- We have to add half-wave plates and quarter wave plates before the detector.
- This way, we get a detector that can measure σ_x , σ_y , and σ_z .

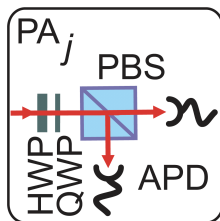

Figure from [W. Wieczorek, R. Krischek, N. Kiesel, P. Michelberger, G. Tóth, and H. Weinfurter, Phys. Rev. Lett. 2009.]

Outline

1 Motivation

- Why is photonic implementation of quantum information processing interesting?

2 A photonic qubits

- How to store a qubit
- How to measure a qubit

3 A photonic singlet (a two-qubit entangled state)

- Parametric downconversion
- Distribution of the photons with beam splitters and postselection

4 Experiment with Dicke states

- Basic ideas of the experiment
- The setup
- The experiment in real life
- The results

Parametric downconversion

- It is possible to create a pair of entangled photons from a single photon.
- This is called spontaneous parametric downconversion (SPDC).
- The crystal is a nonlinear crystal, e.g., a BBO (beta-barium borate) crystal.

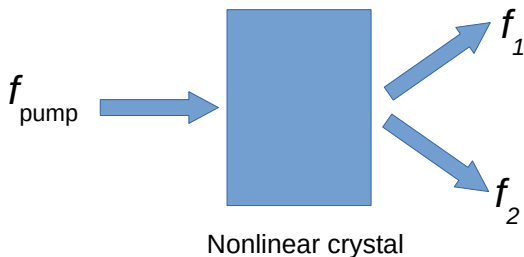

Parametric downconversion II

- The process respects energy conservation

$$f_{\text{pump}} = f_1 + f_2$$

and momentum conservation

$$k_{\text{pump}} = k_1 + k_2$$

for the incoming photon and the outgoing photons. Here f are frequencies and k are wave vectors.

- Typically,

$$f_1 = f_2 = f_{\text{pump}}/2.$$

Hence, the frequency of the incoming photon is twice the frequency of the two outgoing photons.

- The process is probabilistic, its probability can be, e.g., 10^{-6} .
- A laser beam, called "pump" beam is directed into the crystal. Most of the photons pass through the crystal. However, sometimes the photon is down-converted to a photon pair.

Parametric downconversion III

- Depending on, where the outgoing photons exit, there are several types of SPDC.
- For Type II SPDC, the photons have opposite polarizations. If this is also a colinear Type II SPDC, then they pass via the same fibre (rather than one of them going this way, the other going that way.)
- Such a process gives a state

$$\frac{1}{\sqrt{2}}(|HV\rangle + |VH\rangle).$$

This is a symmetric state. It is maximally entangled, similarly to $\frac{1}{\sqrt{2}}(|01\rangle + |10\rangle)$ and $\frac{1}{\sqrt{2}}(|00\rangle + |11\rangle)$.

Parametric downconversion IV

- Thus, we can create a maximally entangled state.

Outline

1 Motivation

- Why is photonic implementation of quantum information processing interesting?

2 A photonic qubits

- How to store a qubit
- How to measure a qubit

3 A photonic singlet (a two-qubit entangled state)

- Parametric downconversion
- Distribution of the photons with beam splitters and postselection

4 Experiment with Dicke states

- Basic ideas of the experiment
- The setup
- The experiment in real life
- The results

Distribution of photons

- Beam splitter. If a photon enters, it is detected either by the first detector, or the other.

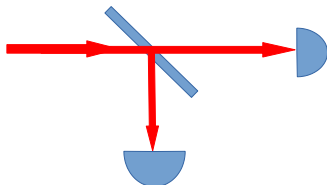

Distribution of photons II

- Based on these, we can make a system that creates a two-qubit entangled state and detects it.

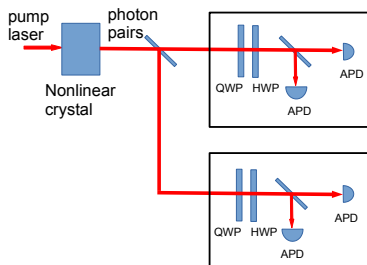

- The two boxes can measure σ_x , σ_x , or σ_y of a photon.

Distribution of photons III

- The system is probabilistic. For only very few pump photon, we get a photon pair.
- From the photon pair, sometimes both photons will go in the top arm, or in the bottom arm. We accept the experiment only if one photons arrives at the top detector, one arrives at at bottom detector.
- The detectors not always click when a photon arrives. Sometimes they do not see the photon.

Outline

1 Motivation

- Why is photonic implementation of quantum information processing interesting?

2 A photonic qubits

- How to store a qubit
- How to measure a qubit

3 A photonic singlet (a two-qubit entangled state)

- Parametric downconversion
- Distribution of the photons with beam splitters and postselection

4 Experiment with Dicke states

- Basic ideas of the experiment
- The setup
- The experiment in real life
- The results

Experiment creating Dicke states

Concrete example: an experiment creating the six-qubit Dicke state

$$|D_6^{(3)}\rangle = \frac{1}{\sqrt{20}} (|111000\rangle + |110100\rangle + \dots + |000111\rangle).$$

[W. Wieczorek, R. Krischek, N. Kiesel, P. Michelberger, G. Tóth, and H. Weinfurter, Phys. Rev. Lett. 103, 020504 (2009).]

SPDC for six photons

- We said that the spontaneous parametric downconversion (SPDC) with some probability gives 1 photon pair.
- With some much smaller probability it can give 2 pairs.
- With some much smaller probability it can give 3 pairs.
- Then 6 photons are leaving the crystal, 3 in H state, 3 in V state.

Outline

1 Motivation

- Why is photonic implementation of quantum information processing interesting?

2 A photonic qubits

- How to store a qubit
- How to measure a qubit

3 A photonic singlet (a two-qubit entangled state)

- Parametric downconversion
- Distribution of the photons with beam splitters and postselection

4 Experiment with Dicke states

- Basic ideas of the experiment
- The setup
- The experiment in real life
- The results

Experiment creating Dicke states

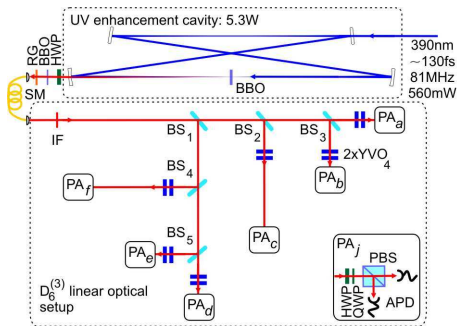

(top part): BBO crystal in a cavity. The pump beam enters on the top right. It exits the cavity via a single-mode (SM) fiber.

(bottom part): the 6 photons are distributed to 6 detector units denoted by PA_j. Each unit can measure σ_x , σ_y , and σ_z .

Outline

1 Motivation

- Why is photonic implementation of quantum information processing interesting?

2 A photonic qubits

- How to store a qubit
- How to measure a qubit

3 A photonic singlet (a two-qubit entangled state)

- Parametric downconversion
- Distribution of the photons with beam splitters and postselection

4 Experiment with Dicke states

- Basic ideas of the experiment
- The setup
- The experiment in real life
- The results

The experiment in real life

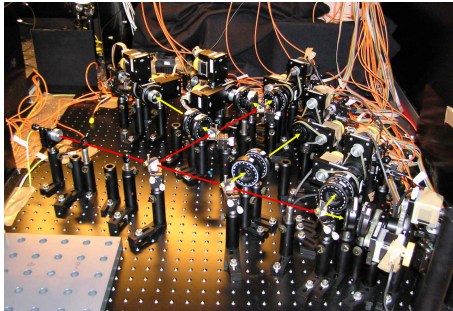
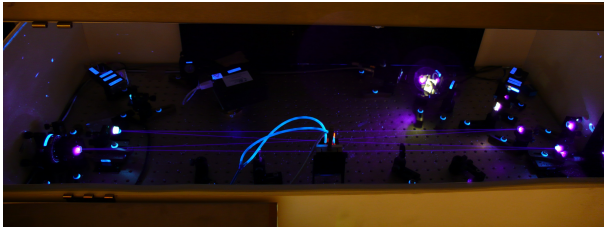

Outline

1 Motivation

- Why is photonic implementation of quantum information processing interesting?

2 A photonic qubits

- How to store a qubit
- How to measure a qubit

3 A photonic singlet (a two-qubit entangled state)

- Parametric downconversion
- Distribution of the photons with beam splitters and postselection

4 Experiment with Dicke states

- Basic ideas of the experiment
- The setup
- The experiment in real life
- The results

Measurements in the various bases

Measuring in the $\sigma_z^{\otimes 6}$, $\sigma_x^{\otimes 6}$ and $\sigma_y^{\otimes 6}$ bases.

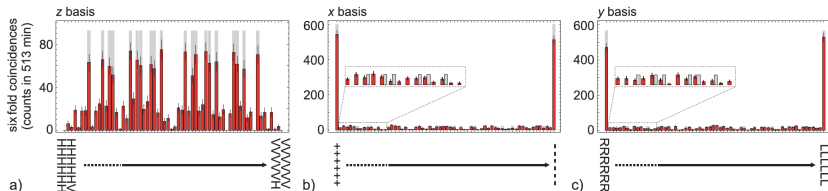

FIG. 2 (color online). Experimentally measured coincidences for the bases (a) z , (b) x , and (c) y with eigenvectors $|H$ or $V\rangle$, $|\pm\rangle$, and $|L$ or $R\rangle$, respectively. Theoretical predictions are shown as pale gray bars normalized to the total number of coincidences. The insets in (b) and (c) are magnified views of a part of all coincidences, where for clarity expected counts are shown next to experimental ones.

- On Figure 2.a, there are ideally 20 peaks corresponding to the 20 product states with 3 H's and 3V's.

[W. Wieczorek, R. Krischek, N. Kiesel, P. Michelberger, G. Tóth, and H. Weinfurter, Phys. Rev. Lett. 103, 020504 (2009).]

Quality of the measurement result: Fidelity

- The Fidelity is given by

$$F_{D_6^{(3)}} = \text{Tr}(|D_6^{(3)}\rangle\langle D_6^{(3)}|\rho) = 0.654 \pm 0.024.$$

(See page 3, top left column, in the paper.)

- This characterizes how good the state has been prepared, it is between 0 and 1.

Entanglement witness

- There is an entanglement witness defined as

$$\mathcal{W}_g = 0.6 - |D_6^{(3)}\rangle\langle D_6^{(3)}|.$$

- For this witness

$$\langle \mathcal{W}_g \rangle = 0.6 - F_{D_6^{(3)}}.$$

- We get

$$\langle \mathcal{W}_g \rangle = -0.054 \pm 0.024.$$

It is negative, thus the state is detected as entangled.
(See page 3, top left column, in the paper.)

- In fact, the state is not only entangled, but full 6-particle entangled.

The density matrix

6-qubit Quantum state tomography gives the 64×64 density matrix of a Dicke state, in another paper.

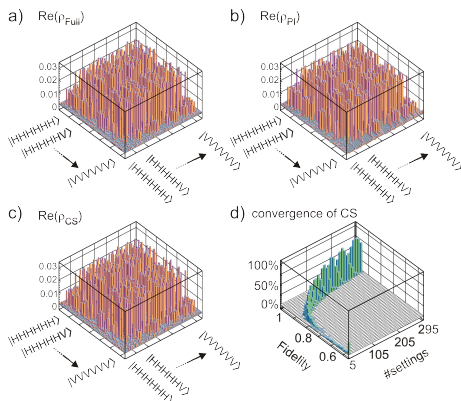

[C. Schwemmer, G. Tóth, A. Niggebaum, T. Moroder, D. Gross, O. Gühne, and H. Weinfurter, Efficient Tomographic Analysis of a Six Photon State, Phys. Rev. Lett. 103, 020504 (2009).]

Conclusions

- We discussed how to use photons for quantum information processing.

www.gtoth.eu

THANK YOU FOR YOUR ATTENTION!

